

ACURA SPA SYSTEMS, INC.

POWER MASTER™ SERIES-211

MODEL: **PM50SP1H5B1S1G**

240V 50A. Service 60 Hz

REVISION: 7/20/2009 \* Optional Items

PC Board Part Number: 2631-120

**WARNING: MUST BE WIRED PER NATIONAL ELECTRIC CODE AND ALL LOCAL CODES AND REGULATIONS.**

NOTE: To supply 120V to the heater, move RED wire on load side of **Terminal Block** from RED (L2) to WHITE (N).

NOTE: To supply 120V to the pump, move BLUE wire on load side of **Terminal Block** from RED (L2) to WHITE (N).

NOTE: Standard heater is 5.5kW, optional 4kW can be substituted.

Output Connectors

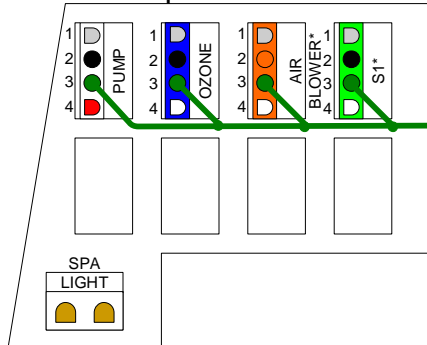

PM50SP2H5B1S1G	
PM	= Megatrol Series
50	= 50 Amp Service; 37.5 Amp Rated
SP1	= Single Pump, 120V
H5	= Single Heater, 5.5kW
B1	= Blower, 120V
S1	= Receptacle, 120V
G	= G.F.C.I.

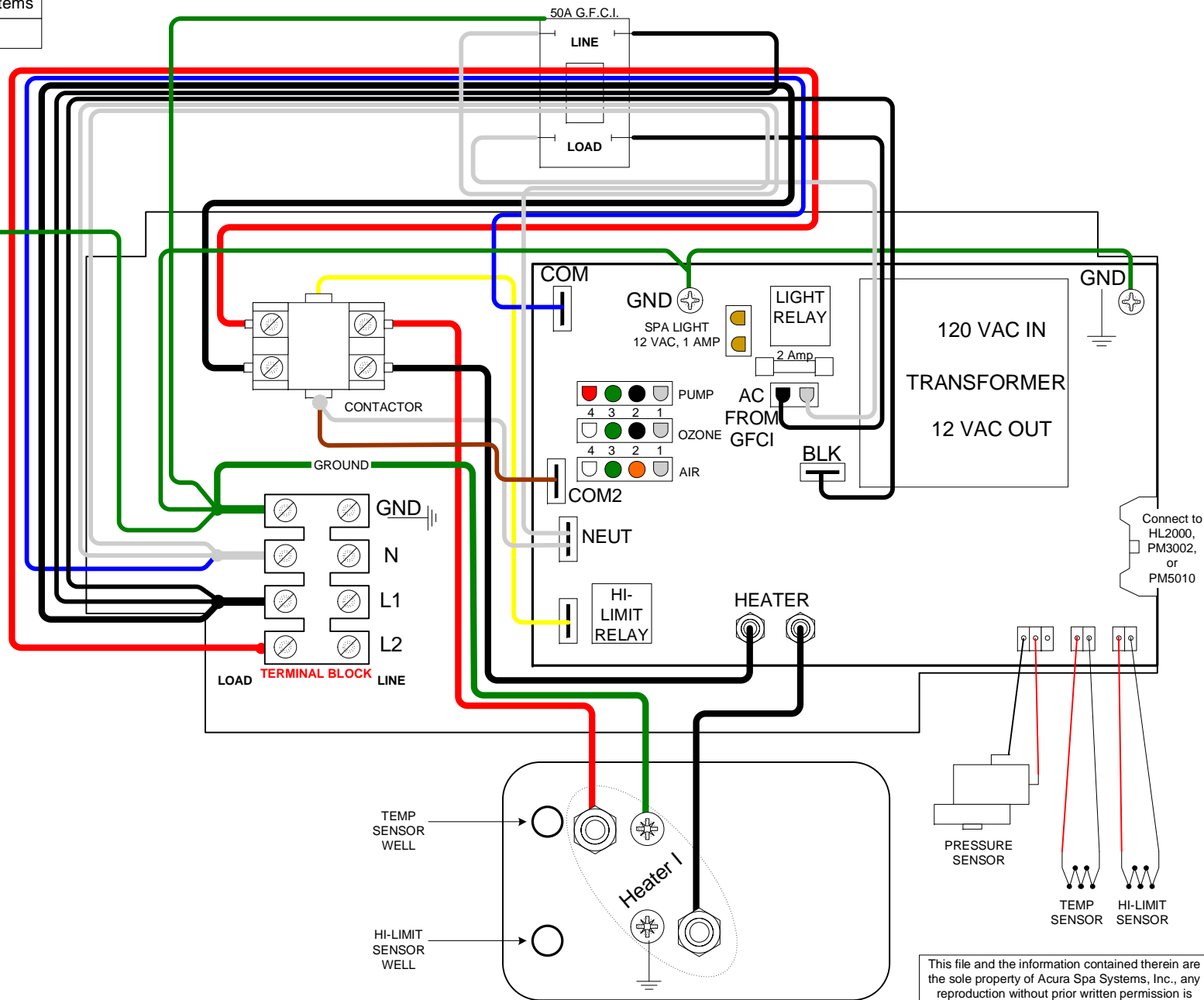

This file and the information contained therein are the sole property of Acura Spa Systems, Inc., any reproduction without prior written permission is strictly forbidden.